

TCA 150

TESTATA DI COMANDO
DRIVING HEAD

PIEDE
TAIL

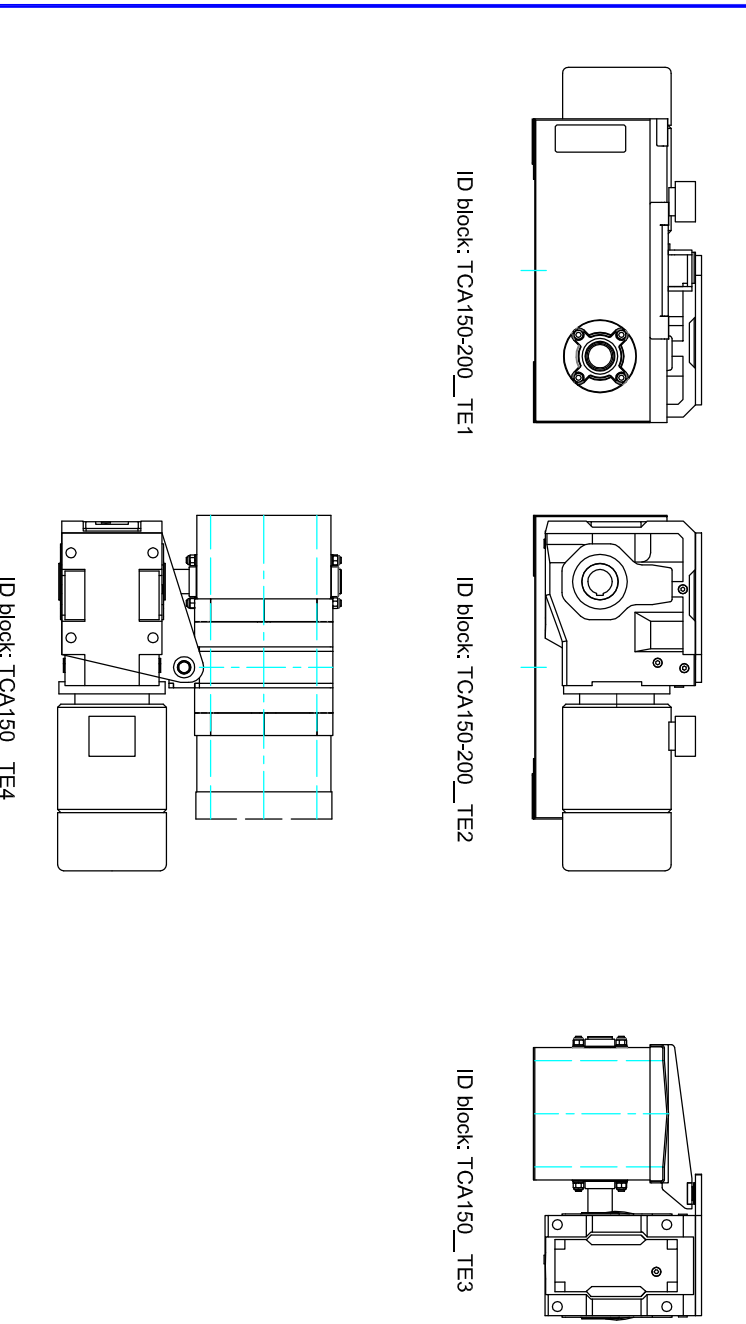

CASSE STANDARD
STANDARD CASINGS

CASSE ALIMENTAZIONE LATERALE
SIDE INLET CASING

CASSA REGOLAZIONE FLUSSO
CASING WITH FLOW REGULATION SYSTEM

L=900

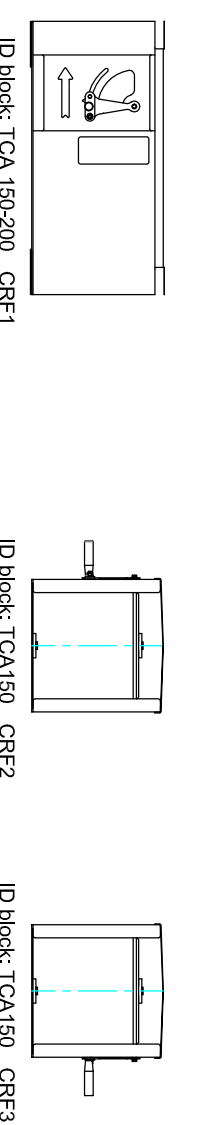

L=2400

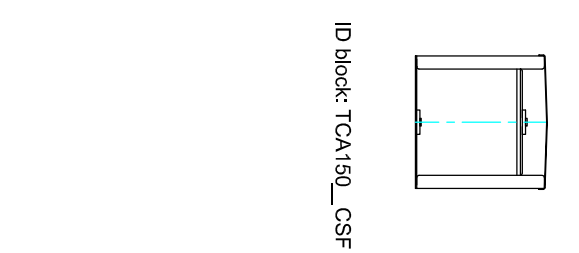

L=900

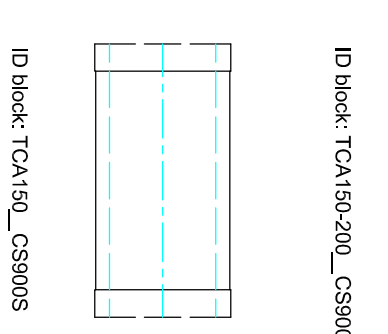

L=1900

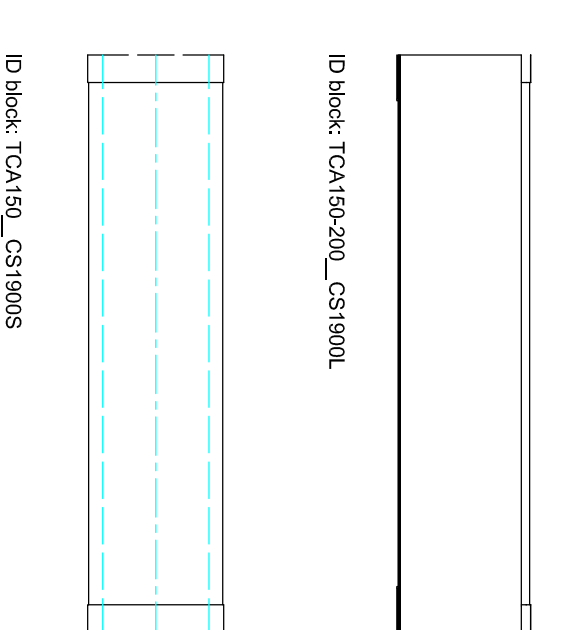

L=400

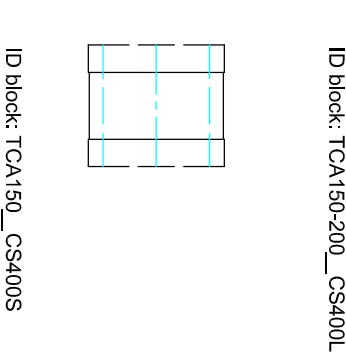

L=1400

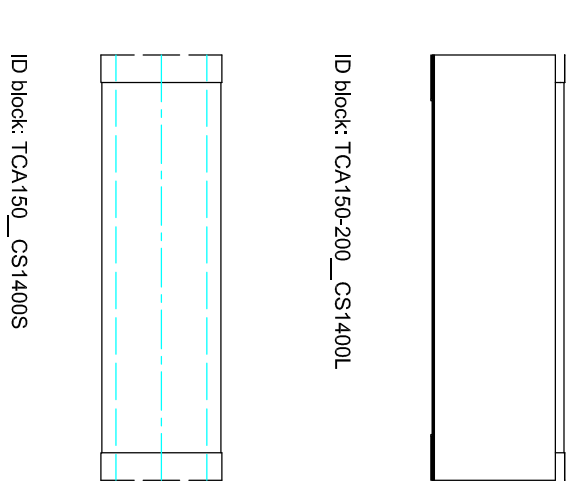

L=1400

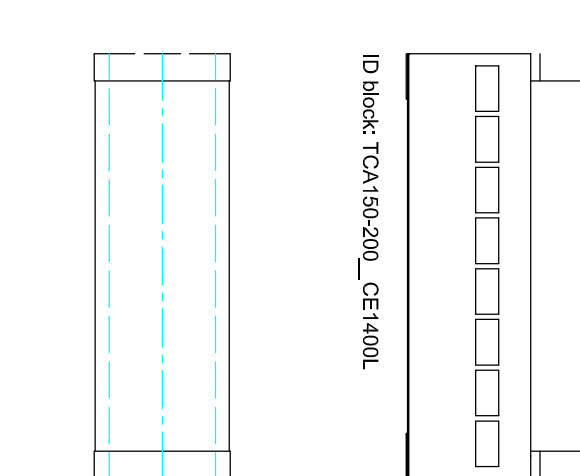

L=400

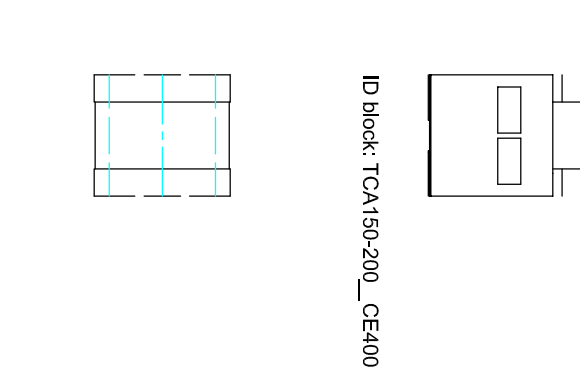

CASSE DOPPIE
DOUBLE CASINGS

TRAMOGGIA DI ALIMENTAZIONE 300X300
SQUARE INLET HOPPER 300X300

SERRANDA LONGITUDINALE MANUALE
LONGITUDINAL MANUAL SLIDE

L=2400

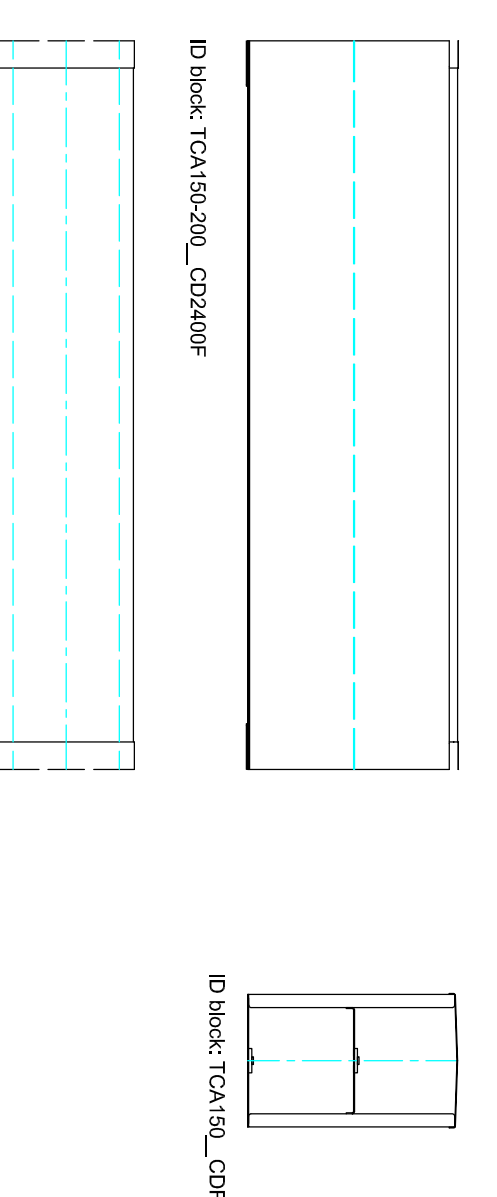

L=900

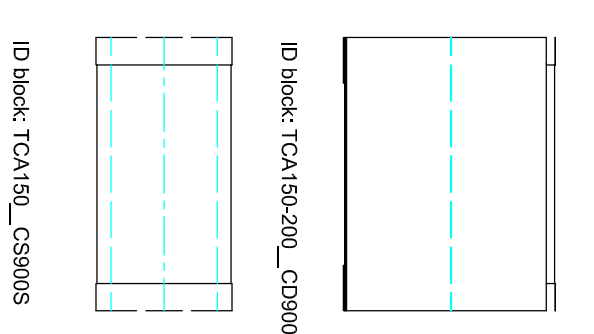

L=1900

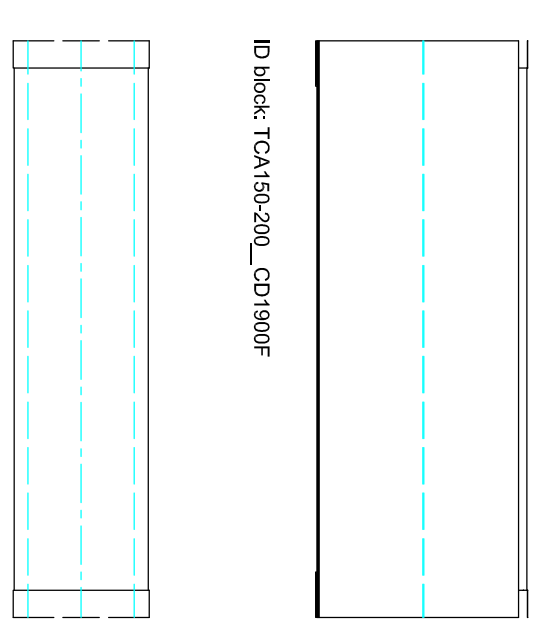

L=400

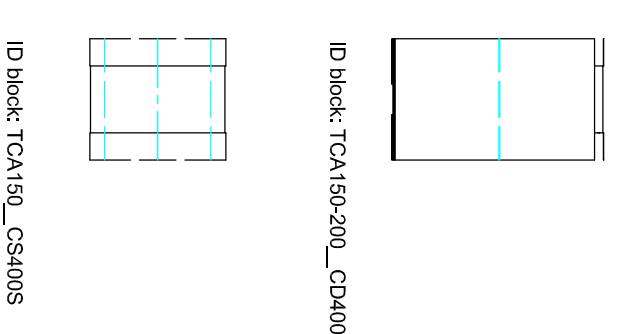

TRAMOGGIA DI SCARICO 300X300
SQUARE OUTLET HOPPER 300X300

SERRANDA LONGITUDINALE MOTORIZZATA
LONGITUDINAL RACK SLIDE

L=1400

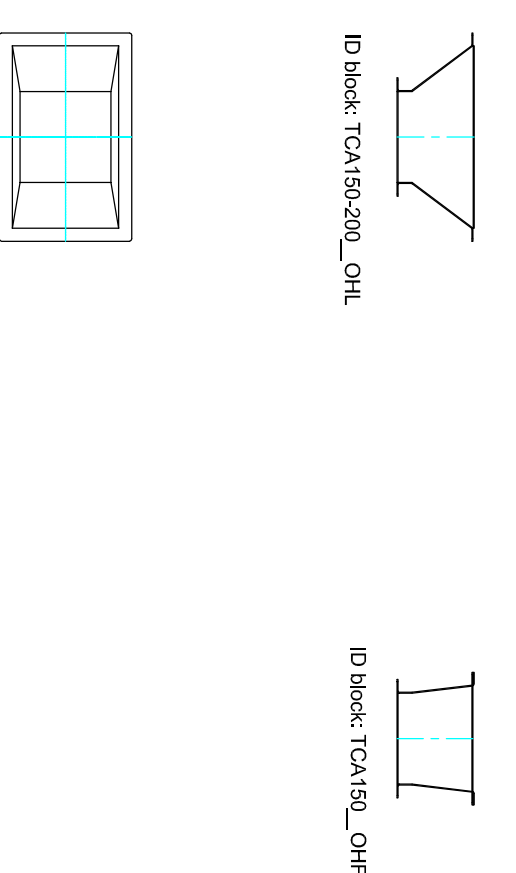
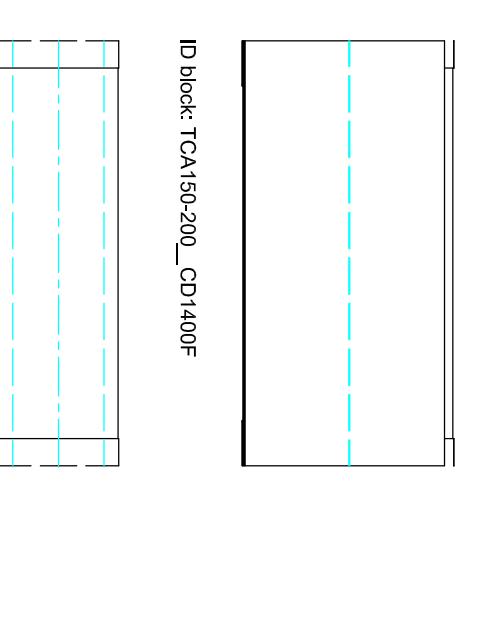

L=2400

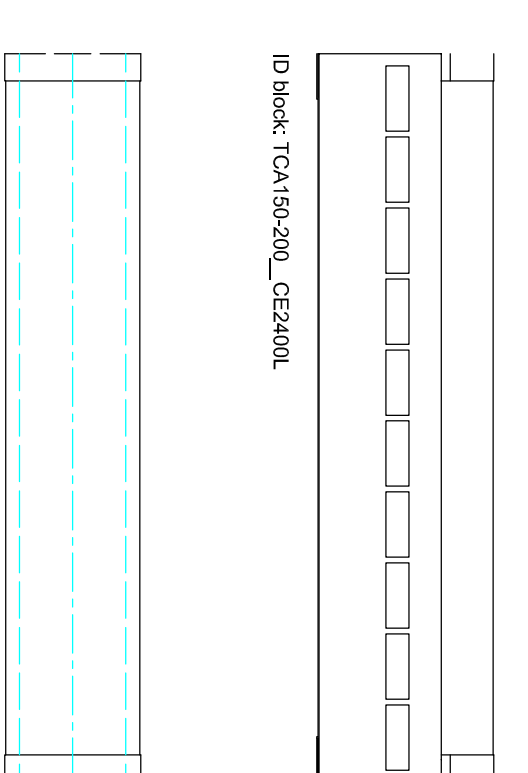

L=1000

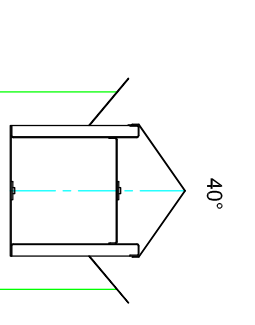
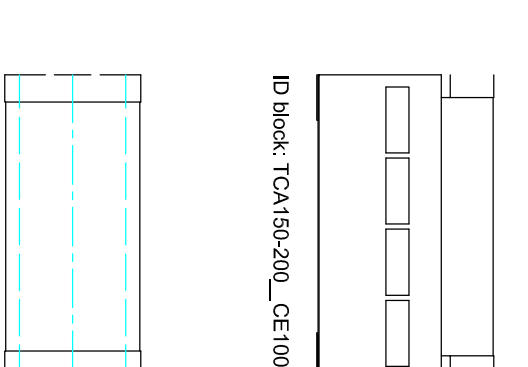

L=1900

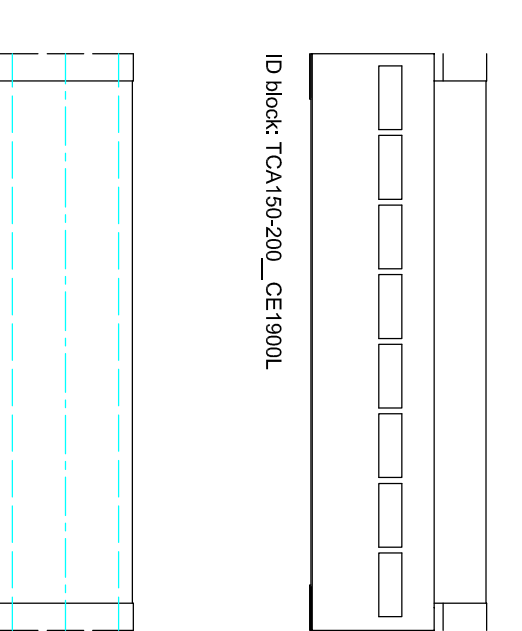

L=900

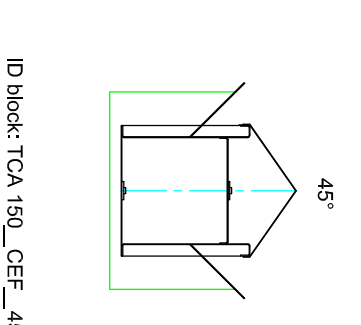
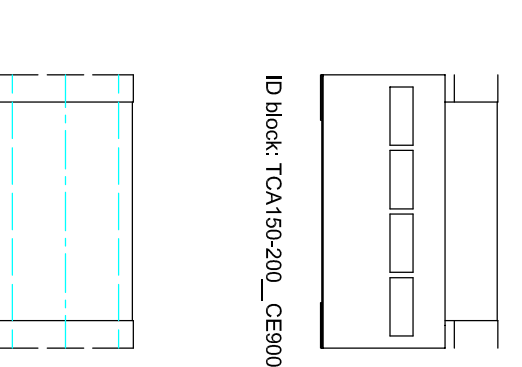

L=1400

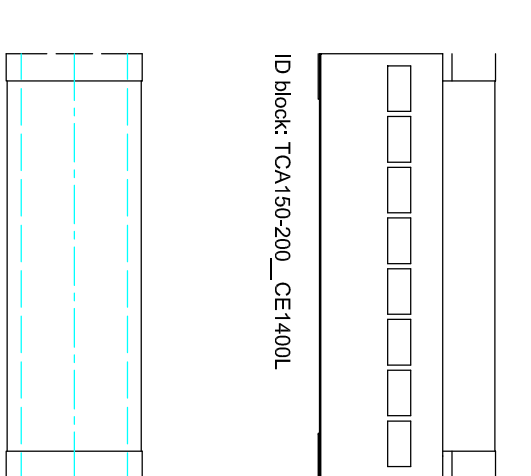

L=400

