

ETM 500

TESTATA DI COMANDO DRIVING HEAD

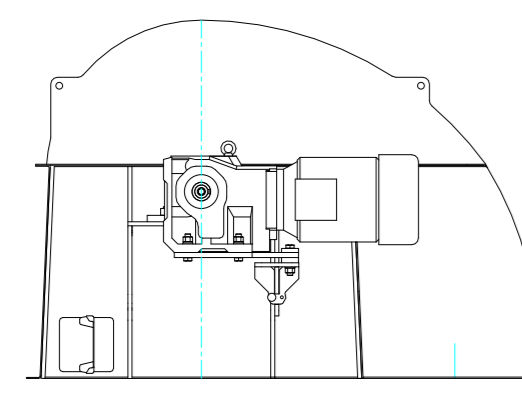

ID block: ETM500_DH1_2011

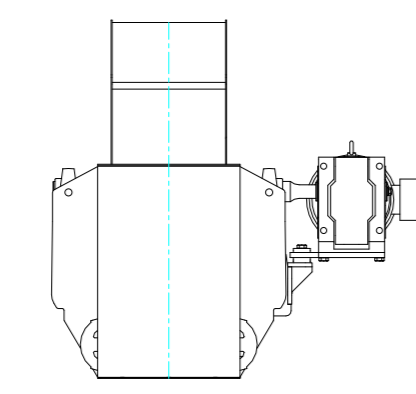

ID block: ETM500_DH2_2011

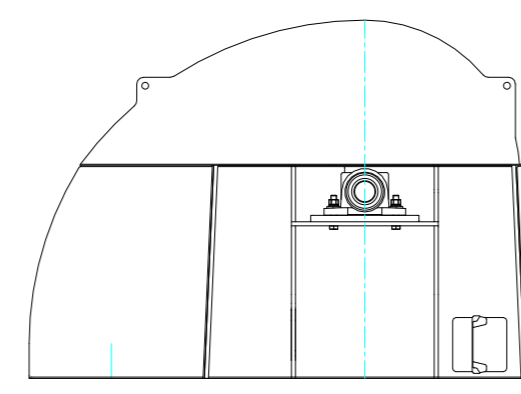

ID block: ETM500_DH3_2011

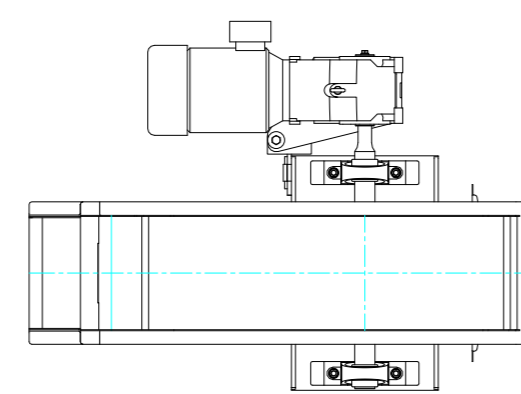

ID block: ETM500_DH4_2011

WEIGHT
PESO
[kg]
950

CANNE STANDARD STANDARD LEGS

L=2900

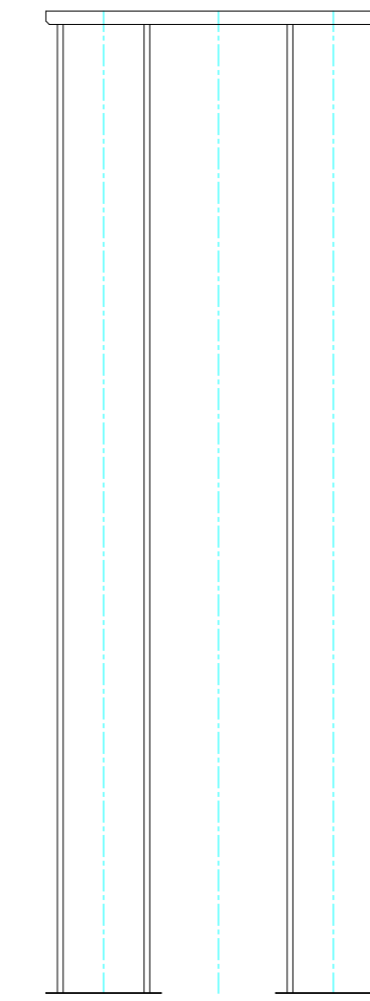

ID block: ETM500_SD2_2011

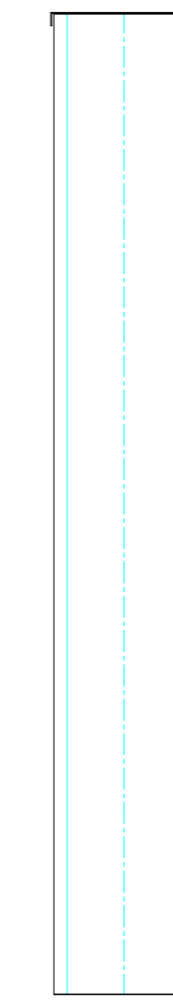

ID block: ETM500_SD3_2011

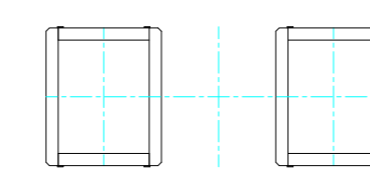

ID block: ETM500_SD1_2011

WEIGHT
PESO
[kg]
120

L=2400

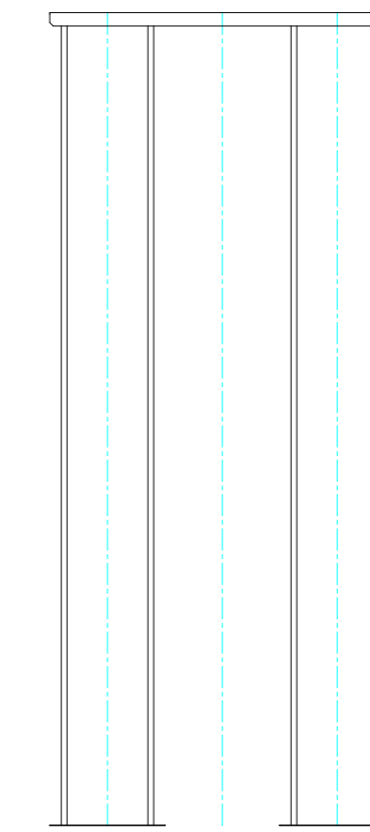

ID block: ETM500_SD4_2011

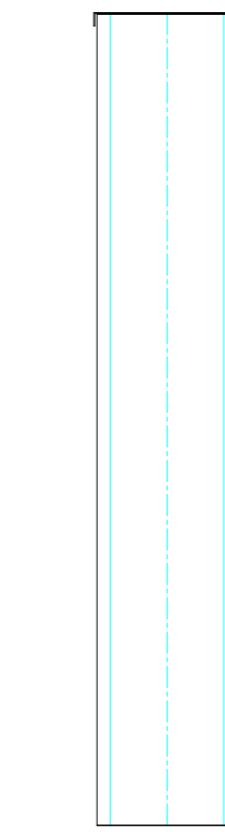

ID block: ETM500_SD5_2011

L=1900

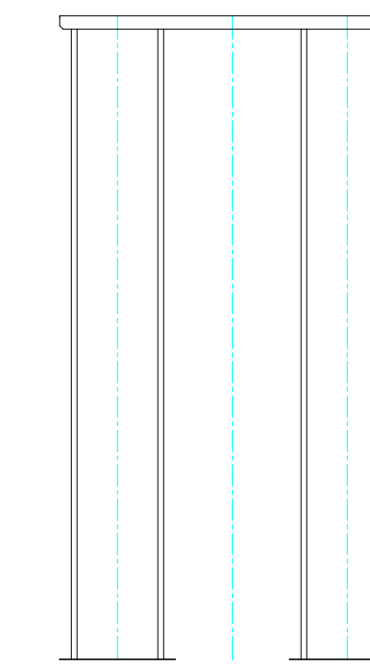

ID block: ETM500_SD6_2011

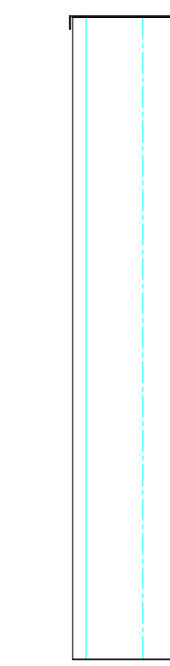

ID block: ETM500_SD7_2011

PIEDE TAIL

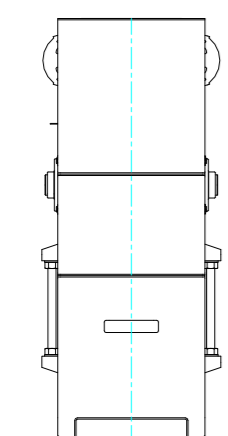

ID block: ETM500_T1_2011

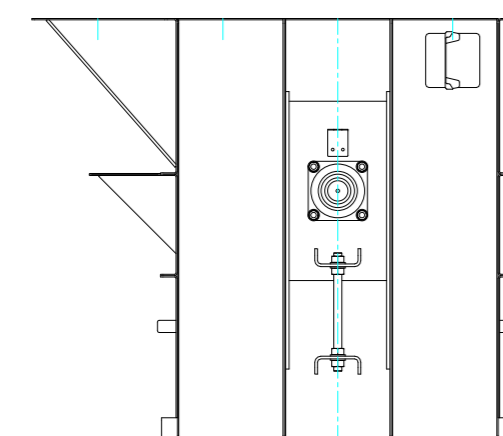

ID block: ETM500_T3_2011

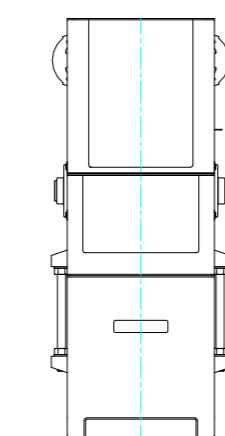

ID block: ETM500_T4_2011

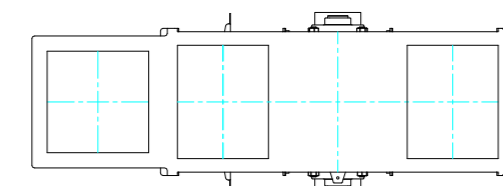

ID block: ETM500_T2_2011

WEIGHT
PESO
[kg]
280

L=1400

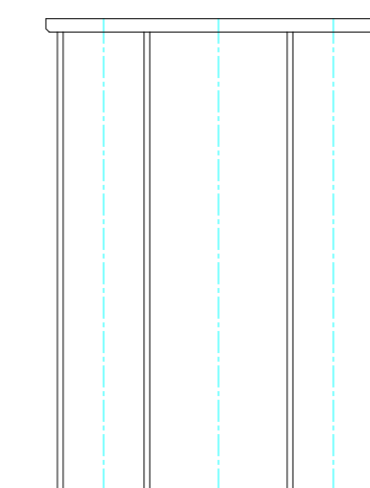

ID block: ETM500_SD8_2011

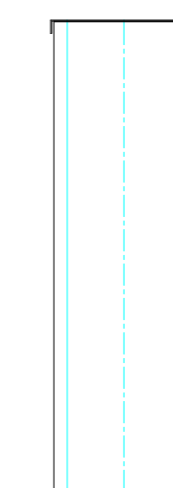

ID block: ETM500_SD9_2011

L=900

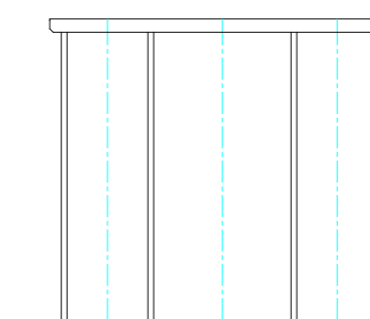

ID block: ETM500_SD10_2011

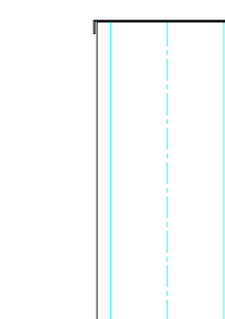

ID block: ETM500_SD11_2011

L=400

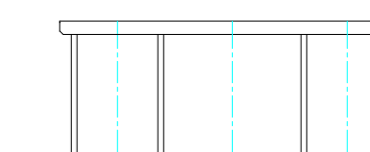

ID block: ETM500_SD12_2011

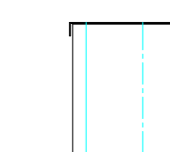

ID block: ETM500_SD13_2011

CANNA D'ISPEZIONE INSPECTION LEG

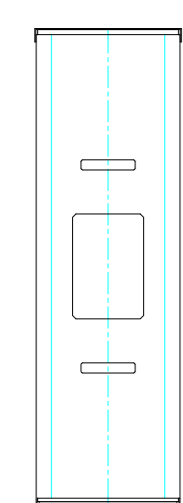

ID block: ETM500_ID2_2011

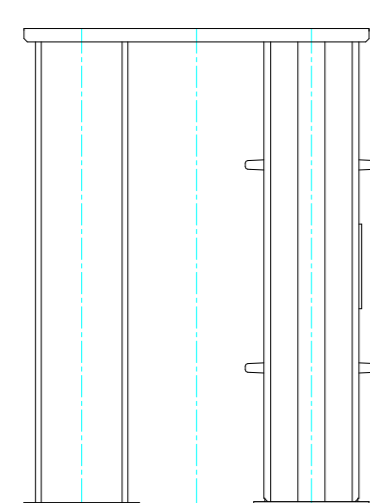

ID block: ETM500_ID1_2011

DISTANZIALE CANNE SPACER BETWEEN LEGS

ID block: ETM500_DI_2012

ID block: ETM500_DF_2012

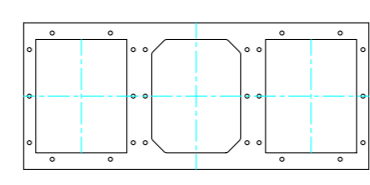

ID block: ETM500_DS_2012

TRAM. DI SCARICO 250X250 OUTLET HOPPER 250X250

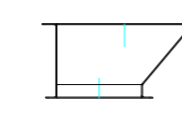

ID block: ETM500_SH4_2011

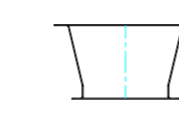

ID block: ETM500_SH6_2011

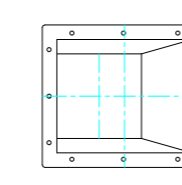

ID block: ETM500_SH5_2011

TRAM. DI SCARICO 300X300 OUTLET HOPPER 300X300

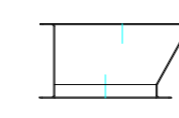

ID block: ETM500_SH2_2011

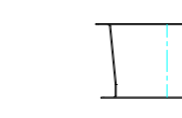

ID block: ETM500_SH1_2011

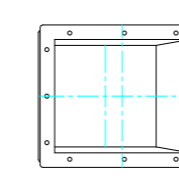

ID block: ETM500_SH3_2011

ASPIRAZIONE Ø100 ASPIRATION Ø100

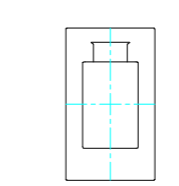

ID block: ETM500_AD7_2012

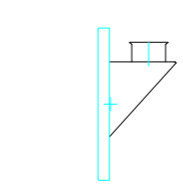

ID block: ETM500_AD8_2012

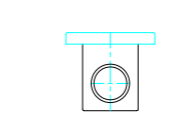

ID block: ETM500_AD9_2012

ASPIRAZIONE Ø120 ASPIRATION Ø120

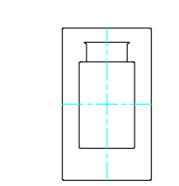

ID block: ETM500_AD4_2012

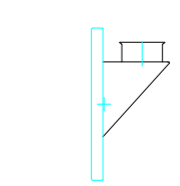

ID block: ETM500_AD5_2012

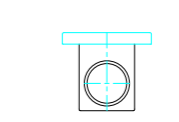

ID block: ETM500_AD6_2012

ASPIRAZIONE Ø150 ASPIRATION Ø150

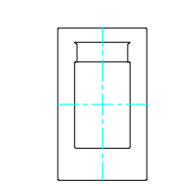

ID block: ETM500_AD1_2011

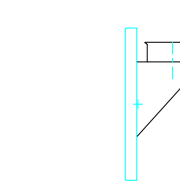

ID block: ETM500_AD2_2011

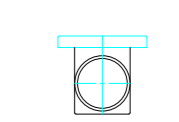

ID block: ETM500_AD3_2011

0	EMMISSIONE / EMISSION	U.T. PTM	01/12
Scale	1:1	Objetto	NORMALINI TECNICI ELEVATORE A TAZZE
SERIE ETM 500 TECHNICAL DRAWING BUCKET ELEVATOR TYPE ETM 500			

