

ETM 400

TESTATA DI COMANDO DRIVING HEAD

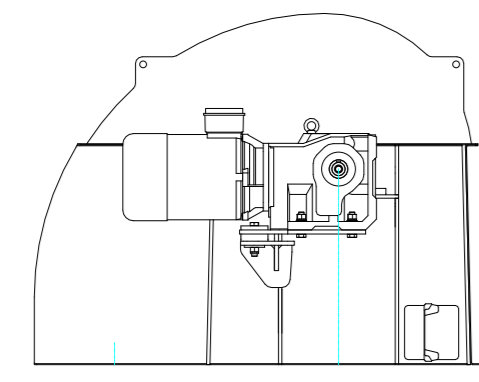

ID block: ETM400_DH1_2011

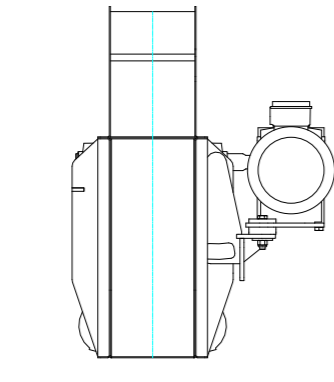

ID block: ETM400_DH4_2011

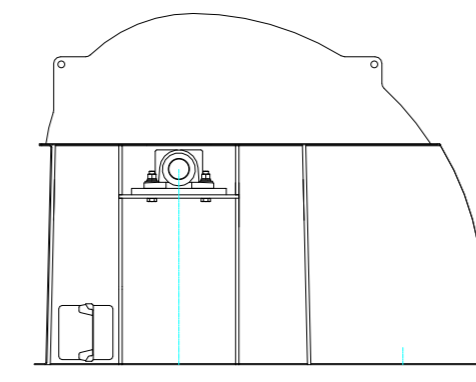

ID block: ETM400_DH2_2011

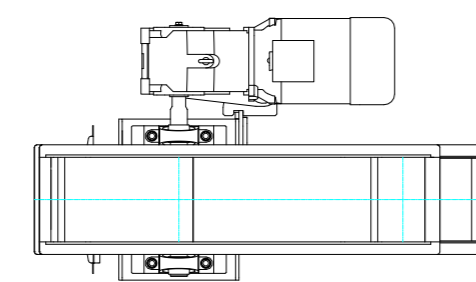

ID block: ETM400_DHS_2011

WEIGHT

PESO

[kg]

409

CANNE STANDARD STANDARD LEGS

L=2900

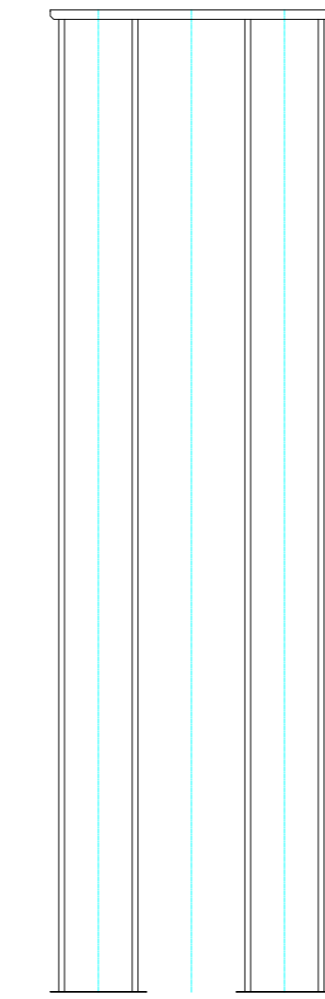

ID block: ETM400_SD2_2011

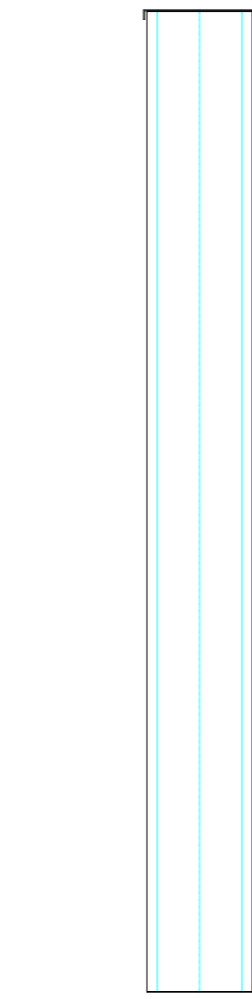

ID block: ETM400_SD3_2011

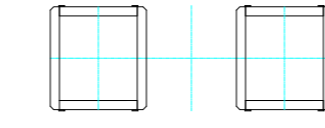

ID block: ETM400_SD1_2011

WEIGHT

PESO

[kg/m]

75

L=2400

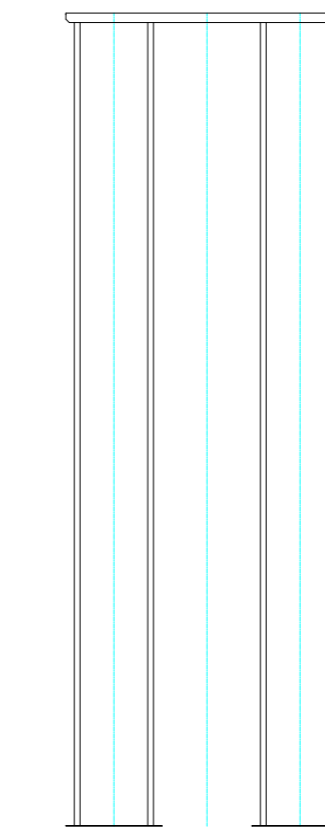

ID block: ETM400_SD4_2011

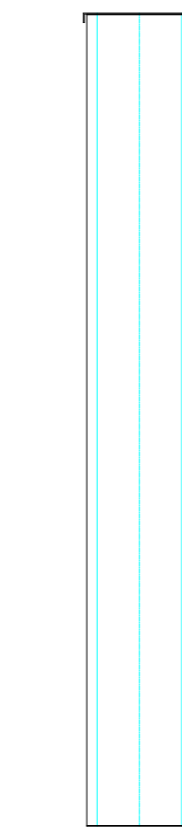

ID block: ETM400_SD5_2011

L=1900

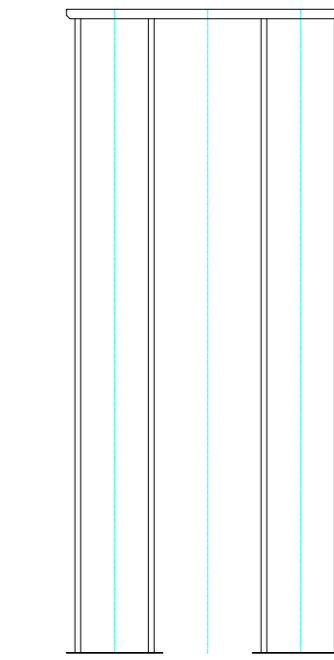

ID block: ETM400_SD6_2011

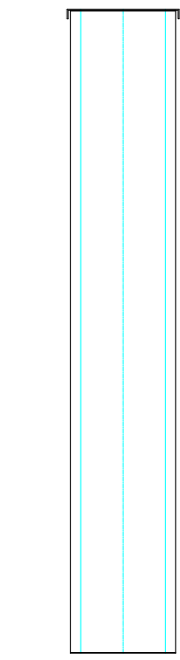

ID block: ETM400_SD7_2011

PIEDE TAIL

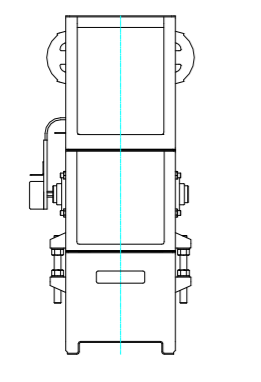

ID block: ETM400_T3_2011

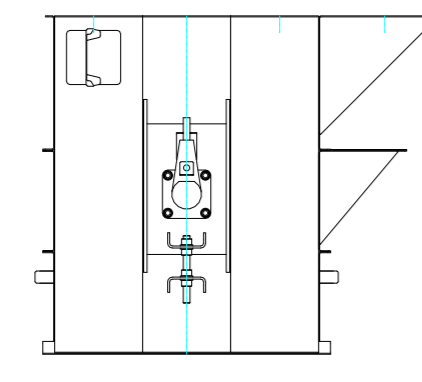

ID block: ETM400_T2_2011

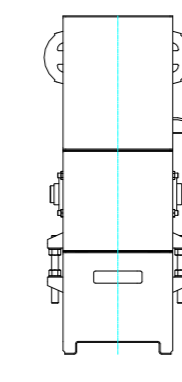

ID block: ETM400_T1_2011

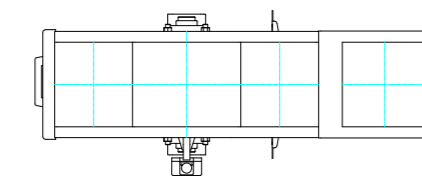

ID block: ETM400_T4_2011

WEIGHT

PESO

[kg]

142

L=1400

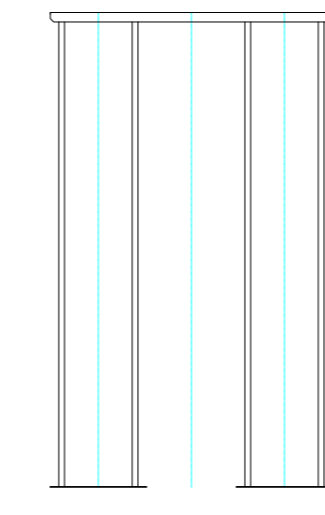

ID block: ETM400_SD8_2011

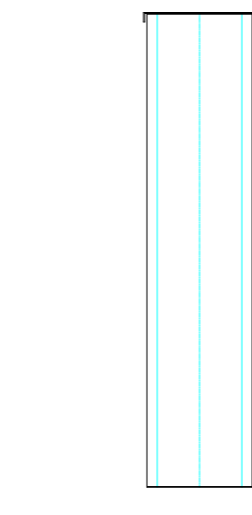

ID block: ETM400_SD9_2011

L=900

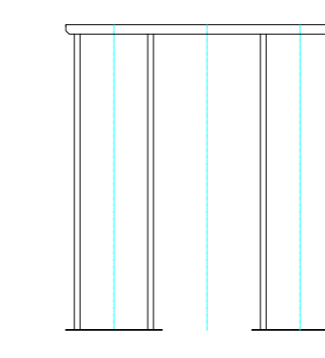

ID block: ETM400_SD10_2011

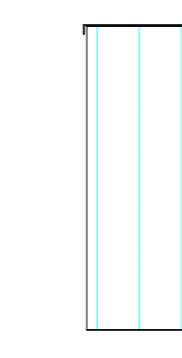

ID block: ETM400_SD11_2011

L=400

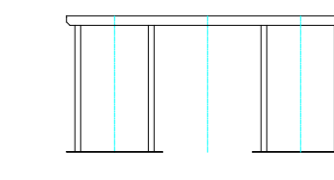

ID block: ETM400_SD12_2011

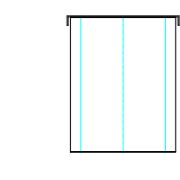

ID block: ETM400_SD13_2011

CANNA D'ISPEZIONE INSPECTION LEG

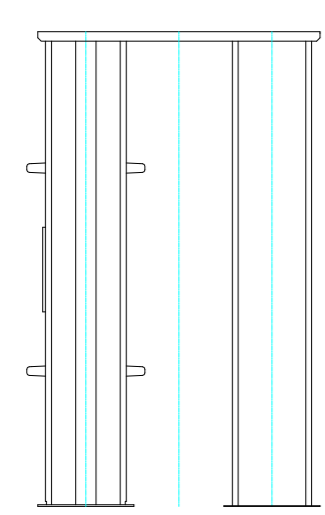

ID block: ETM400_ID1_2011

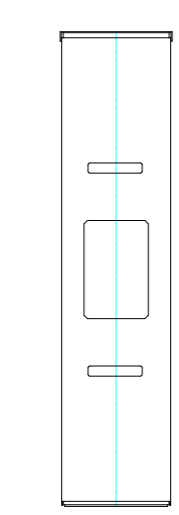

ID block: ETM400_ID2_2011

DISTANZIALE CANNE SPACER BETWEEN LEGS

ID block: ETM400_DL_2012

ID block: ETM400_DF_2012

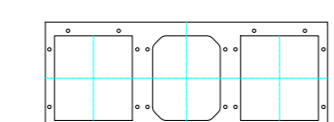

ID block: ETM400_DS_2012

ASPIRAZIONE Ø100 ASPIRATION Ø100

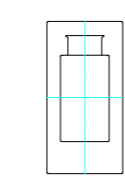

ID block: ETM400_AD1_2011

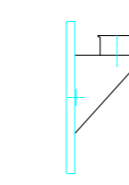

ID block: ETM400_AD2_2011

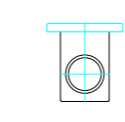

ID block: ETM400_AD3_2011

ASPIRAZIONE Ø120 ASPIRATION Ø120

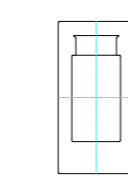

ID block: ETM400_AD4_2012

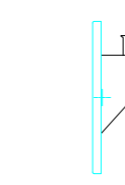

ID block: ETM400_AD5_2012

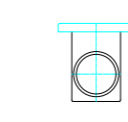

ID block: ETM400_AD6_2012

TRAMOGGIA DI SCARICO 250x250 OUTLET HOPPER 250x250

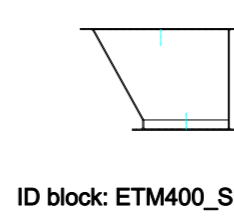

ID block: ETM400_SH2_2011



ID block: ETM400_SH3_2011

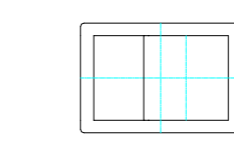

ID block: ETM400_SH4_2011

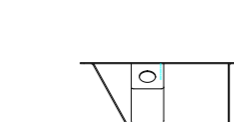

ID block: ETM400_SHC1_2011

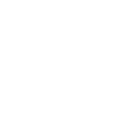

ID block: ETM400_SHC2_2011

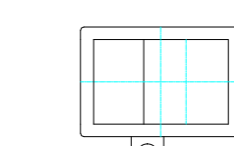

ID block: ETM400_SHC3_2011

TRAMOGGIA DI SCARICO 200x200 OUTLET HOPPER 200x200

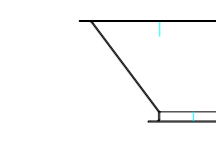

ID block: ETM400_SH5_2012

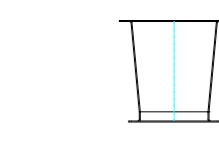

ID block: ETM400_SH6_2012

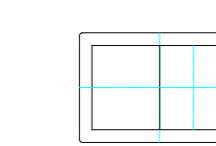

ID block: ETM400_SH7_2012

0	EMMISSIONE / EMISSION	Descrizione modifica:	U.T. PTM	01/12
Scale	1:1	Object	DATA	01/01/2012
AZIENDA CON SISTEMA DI GESTIONE PER LA QUALITÀ CERTIFICATO DA UNI EN ISO 9001:2008 COMPARTO PER QUALITÀ MANAGEMENT CERTIFICATO DA UNI EN ISO 9001:2008		SERIE ETM 400 TECHNICAL DRAWING BUCKET ELEVATOR TYPE ETM 400	PTA PRODUZIONE TECNICA E MARKETING 38062 ESTE (PD) ITALY Via Mark Twain, 10 Tel. 049 8082000 Fax 049 8082001 Email: info@ptaelevator.com	

