

Inspection Hatch Collar

Water Tank Installation and Storage Instructions

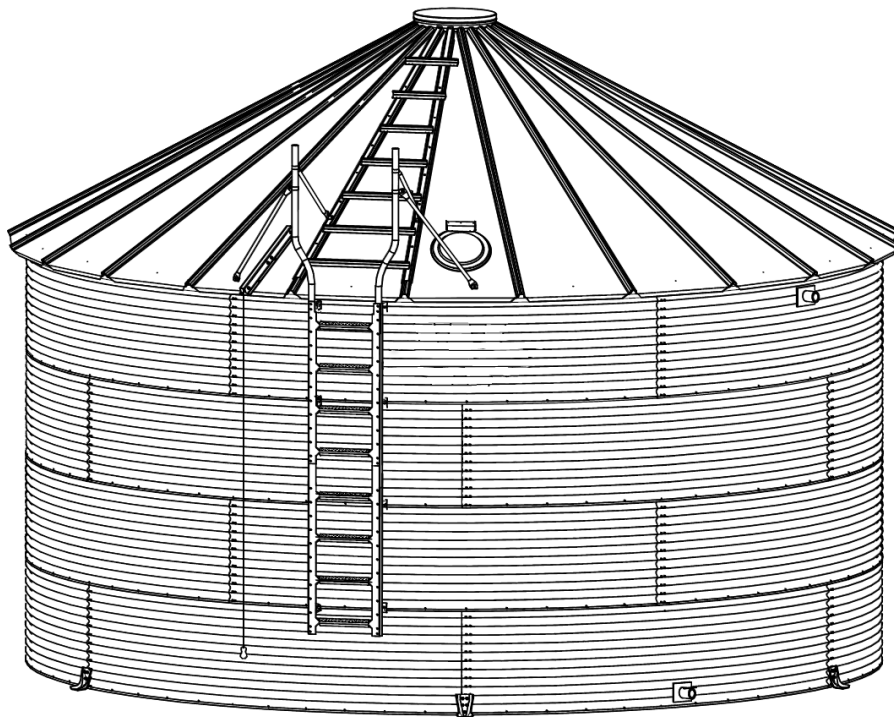

Read this manual before using product. Failure to follow instructions and safety precautions can result in serious injury, death, or property damage. Keep manual for future reference.

Part Number: 199594 R6

Revised: November 2020

Original Instructions

New in this Manual

The following changes have been made in this revision of the manual:

Description	Section
Falling Hazard decal 8110-00136 has been replaced by new decal 8110-00228.	Figure 1 on page 7

CONTENTS

- 1. Introduction 4**
- 2. Safety..... 5**
 - 2.1 Safety Alert Symbol and Signal Words..... 5
 - 2.2 General Safety 5
 - 2.3 Personal Protective Equipment..... 6
 - 2.4 Safety Decals 6
 - 2.5 Decal Installation/Replacement 6
 - 2.6 Safety Decal Locations and Details 7
- 3. Before You Begin 10**
 - 3.1 Tank Design and Capacity 10
 - 3.1.1 Roof Design Capacities for Non-Structural Roofs 11
 - 3.1.2 Roof Design Capacities for Structural Roofs 12
 - 3.2 Site and Assembly 13
 - 3.3 Methods of Installation 13
 - 3.4 Critical Assembly Requirements 13
 - 3.5 Product Storage 14
 - 3.6 Important Notes 15
 - 3.7 Planning and Timing 15
- 4. Preparation 17**
 - 4.1 Check Shipment..... 17
 - 4.2 List of Tools and Equipment..... 17
 - 4.3 Order Optional Equipment..... 17
- 5. Assembly 18**
 - 5.1 Assembly Safety 18
 - 5.2 Installation Instructions..... 19
- 6. Appendix 21**
 - 6.1 Inspection Hatch Parts Boxes..... 21
 - 6.2 Recommended Bolt Assembly 22
- 7. Limited Warranty: Westeel Water Tank Containment Systems 23**

1. Introduction

Before assembling, please read this manual. Familiarize yourself with the process and the necessary precautions for efficient and safe assembly of this Westeel Inspection Hatch Collar.

Everyone present at the assembly site is required to be familiar with all safety precautions.

Keep this manual available for frequent reference and review it with new personnel. Call your local distributor or dealer if you need assistance or additional information.



2. Safety

2.1. Safety Alert Symbol and Signal Words



This safety alert symbol indicates important safety messages in this manual. When you see this symbol, be alert to the possibility of injury or death, carefully read the message that follows, and inform others.

Signal Words: Note the use of the signal words **DANGER**, **WARNING**, **CAUTION**, and **NOTICE** with the safety messages. The appropriate signal word for each message has been selected using the definitions below as a guideline.

-  **DANGER** Indicates an imminently hazardous situation that, if not avoided, will result in serious injury or death.
-  **WARNING** Indicates a hazardous situation that, if not avoided, could result in serious injury or death.
-  **CAUTION** Indicates a hazardous situation that, if not avoided, may result in minor or moderate injury.
- NOTICE** Indicates a potentially hazardous situation that, if not avoided, may result in property damage.

2.2. General Safety

Read and understand all safety instructions, safety decals, and manuals and follow them when assembling the equipment.

- 
 Only experienced personnel who are familiar with this type of assembly and installation should perform this work. Untrained assemblers/installers expose themselves and bystanders to possible serious injury or death.
- Do not modify the inspection hatch collar in any way or deviate from the instructions in this manual without written permission from the manufacturer. Unauthorized modification or methods may impair the function and/or safety. Any unauthorized modification will void the warranty.
- Follow a health and safety program for your worksite. Contact your local occupational health and safety organization for information.
- Contact your local representative or Westeel if you need assistance or additional information.
- Always follow applicable local codes and regulations.

2.3. Personal Protective Equipment

The following Personal Protective Equipment (PPE) should be worn when installing the equipment.

Safety Glasses

- Wear safety glasses at all times to protect eyes from debris.

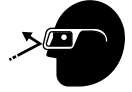

Coveralls

- Wear coveralls to protect skin.



Hard Hat

- Wear a hard hat to help protect your head.



Steel-Toe Boots

- Wear steel-toe boots to protect feet from falling debris.



Work Gloves

- Wear work gloves to protect your hands from sharp and rough edges.



2.4. Safety Decals

- Keep safety decals clean and legible at all times.
- Replace safety decals that are missing or have become illegible. See decal location figures that follow.
- Replaced parts must display the same decal(s) as the original part.
- Replacement safety decals are available **free of charge** from your distributor, dealer, or factory as applicable.

2.5. Decal Installation/Replacement

1. Decal area must be clean and dry, with a temperature above 50°F (10°C).
2. Decide on the exact position before you remove the backing paper.
3. Align the decal over the specified area and carefully press the small portion with the exposed sticky backing in place.
4. Slowly peel back the remaining paper and carefully smooth the remaining portion of the decal in place.
5. Small air pockets can be pierced with a pin and smoothed out using the decal backing paper.

2.6. Safety Decal Locations and Details

Replicas of the safety decals that are attached to the inspection hatch collar and their messages are shown in the figure(s) that follow. Safe operation and use of the inspection hatch collar requires that you familiarize yourself with the various safety decals and the areas or particular functions that the decals apply to, as well as the safety precautions that must be taken to avoid serious injury, death, or damage.

Figure 1. Safety Decals

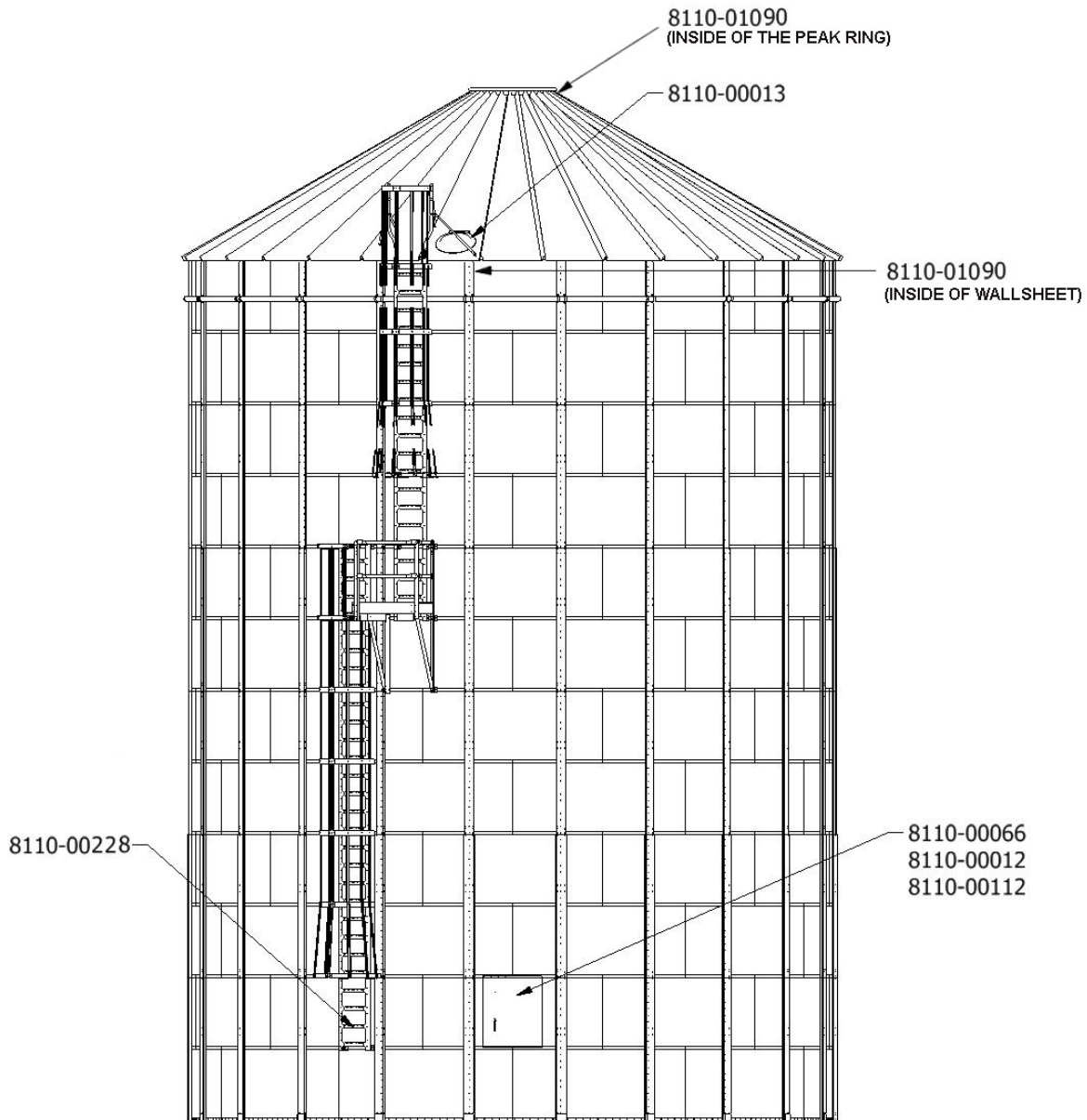





 WARNING	
	
SAFETY INSTRUCTIONS	
<ul style="list-style-type: none"> • Read operator’s manual and all safety decals before assembling, using, or servicing bin. • Close/latch all access doors when not in use. • Do not alter or modify bin structure. • Replace any damaged components only with factory made components. • This bin should only be used to store free flowing, granular material, unless specifically designed and marked otherwise. • When filling, use top filler cap and direct material to center of bin. • Do not over-fill bin. Material should not be in contact with or place pressure on roof sheets. 	

Part Number: 8110–00012

 WARNING	
	
ENTRAPMENT HAZARD	
<p>Never enter the bin when loading or unloading grain.</p> <p>If you must enter the bin:</p> <ol style="list-style-type: none"> 1. Shut off and lock out all power. 2. Use a lifeline, safety harness, and have an observer outside before entering the bin. 3. Wear proper breathing equipment or a respirator. 4. Avoid the center of the bin. <p>Failure to heed these warnings could result in serious injury or death.</p>	

Part Number: 8110–00013

 WARNING		
		
Rotating flighting could kill or dismember.	Flowing material could trap and suffocate.	Crusted material could collapse and suffocate.
Keep clear of all augers. DO NOT ENTER this bin!		
<p>If you must enter the bin:</p> <ol style="list-style-type: none"> 1. Shut off and lock out all power. 2. Use a safety harness and safety line. 3. Station another person outside the bin. 4. Avoid the center of the bin. 5. Wear proper breathing equipment or respirator. <p>Failure to heed these warnings could result in serious injury or death.</p>		

Part Number: 8110–00112

WARNING



FALLING HAZARD

To prevent serious injury or death:

- Do not climb ladder if damaged, wet, icy, greasy, or slippery.
- Maintain good balance by having at least three points of contact at all times. Face the ladder while climbing.
- Safe working load is 350 lb (160 kg). Do not overload.
- Do not carry items while climbing.

Part Number: 8110-00228

NOTICE

When equipped with aeration system, to prevent roof and/or bin damage:

- Use a minimum 1 square foot (0.1m²) opening for each 1000ft³/min (30m³/min) of air.
- Ensure all roof vents are open and unobstructed.
- Discontinue use of aeration fan if roof vents become obstructed with ice.

Part Number: 8110-00066



**FALL RESTRAINT
ANCHOR POINT
MAX WORKING LOAD:
1,000 lb [453 kg]**

SEE MANUFACTURER ROOF MANUAL FOR
DETAILED INSTRUCTIONS REGARDING
ANCHOR POINT LOCATIONS

Part Number: 8110-01090

3. Before You Begin

3.1. Tank Design and Capacity

Standard Westeel Water Tanks are designed for:

1. Containment of liquids with a specific gravity of less than or equal to 1.0
2. Maximum horizontal wind pressure based on 94 mph (151 km/h) as per NBCC 2015 and 105 mph (169 km/h) as per ASCE 7-16.
3. Zero seismic activity.

Note

Seismic resistance in water tanks varies with height and diameter. Many standard designs have significant seismic capabilities. Designs can be reviewed and/or modified to reflect local seismic requirements.

4. Roof loading capabilities vary with diameter, peak load and snow load.

- a. Peak Loads – standard peak loads follow. **Upgrades are available.**

Table 1. Peak Loads for Various Roofs

Size	Type of Roof	Load (lbs)	Load (kg)
15' to 24'	non-structural	4000 lbs	1814 kg
27' to 48'	non-structural	5000 lbs	2268 kg
51' & 54'	non-structural	8000 lbs	3629 kg
48' to 108'	structural	10,000 lbs	4536 kg

- b. Roof Snow Loads (RSL) – at the above stated standard peak loads, standard RSLs vary with diameter and range from 16 psf (78 kg/m²) to 45 psf (220 kg/m²). **Upgrades are available.**

Note

The correlation between ground snow load (GSL) and roof snow load (RSL) for water tank designs vary with jurisdictions. In the US $GSL = 2 \times RSL$. In Europe $GSL = 1.25 \times RSL$. In Canada the correlation between GSL and RSL varies and is site specific.

- c. For specific roof design capabilities refer to:

[Section 3.1.1 – Roof Design Capacities for Non-Structural Roofs on page 11](#)

[Section 3.1.2 – Roof Design Capacities for Structural Roofs on page 12](#)

3.1.1 Roof Design Capacities for Non-Structural Roofs

Table 2. Maximum Roof Snow Load at STANDARD Peak Load

Bin Series	Std Peak Load	Standard Roof		Plus Upgrade 1		Plus Upgrade 2	
	lbs (kN)	psf	kPa	psf	kPa	psf	kPa
15	4000 (17.8)	45	2.15	n/a		n/a	
16		45	2.15				
18		45	2.15				
21		30	1.44	49	2.35		
24		21	1.01	40	1.92		
27		24	1.15	39	1.87		
30	5000 (22.2)	20	0.96	32	1.53	40	1.92
33		23	1.10	33	1.58	44	2.11
36		24	1.15	30	1.44	38	1.82
39		22	1.05	27	1.29	36	1.72
42		19	0.91	24	1.15	34	1.63
45		16	0.77	23	1.10	32	1.53
48		21	1.01	26	1.24	33	1.58
51		8000 (35.6)	20	0.96	28	1.34	n/a
54	17		0.81	27	1.29		

Table 3. Maximum Roof Snow Load at UPGRADED Peak Load

Bin Series	Upgraded Peak Load	Standard Roof		Plus Upgrade 1		Plus Upgrade 2			
	lbs (kN)	psf	kPa	psf	kPa	psf	kPa		
15	8000 (35.6)	29	1.39	n/a		n/a			
16		29	1.39						
18		29	1.39						
21		24	1.15	40	1.92				
24		17	0.81	27	1.29				
27	10000 (44.5)	19	0.91	28	1.34	n/a			
30		15	0.72	24	1.15			33	1.58
33		18	0.86	24	1.15			36	1.72
36		18	0.86	23	1.10			31	1.48
39		16	0.77	21	1.01			30	1.44
42		14	0.67	19	0.91			27	1.29
45		13	0.62	18	0.86			25	1.20
48*		16	0.77	21	1.01			26	1.24
51*	12000 (53.4)	14	0.67	21	1.01	n/a			
54*		13	0.62	20	0.96				

Note

- Standard roofs are adequate for many applications but additional capacity is available when optional upgrade packages are used.
- Upgrade packages include roof stiffening rings and/or rib supports.
- For peak load between standard and upgrade limits, a straight line interpolation can be used to determine maximum roof snow load.
- *Structural roofs for 48' – 54' with rafters are available to support peak ring loads greater than loads on [Table 3](#).
- Higher level upgrade kits include all components from lower level kit; only one upgrade kit needs to be ordered for any given bin.

3.1.2 Roof Design Capacities for Structural Roofs

Table 4. Maximum Roof Snow Load at STANDARD Peak Loads

Bin Series	Std Peak Load	Standard Roof	
	lbs (kN)	psf	kPa
48	20000 (89.0)	39	1.87
51		39	1.87
54		39	1.87
60		39	1.87
66		38	1.82
72		38	1.82
75		37	1.77
78		37	1.77
84		37	1.77
90		37	1.77
96		37	1.77
102		32	1.53
105		32	1.53
108		32	1.53

Table 5. Maximum Roof Snow Load at UPGRADED Peak Loads

Bin Series	Upgraded Peak Load	Standard Roof	
	lbs (kN)	psf	kPa
48	60000 (266.9)	38	1.82
51		38	1.82
54		38	1.82
60		38	1.82
66		37	1.77
72		37	1.77
75		36	1.72
78		36	1.72
84		36	1.72
90		34	1.63
96		34	1.63
102		31	1.48
105		31	1.48
108		31	1.48

Note

Standard capacities are provided. Additional capacity is available with optional upgrades.

3.2. Site and Assembly

Unless otherwise specifically provided in writing, Westeel does not take responsibility for any defects or damages to any property, or injury to any persons, arising from or related to any site or assembly considerations, including but not limited to:

- Tank location and tank siting
- Soil conditions and corresponding foundation requirements (note that the examples provided in manuals are for specifically stated soil conditions)
- Tank assembly (Westeel recommends the use of qualified installers; contact Westeel for information on installers in your area)
- Field modifications or equipment additions that affect the tank structure
- Interconnections with neighboring structures
- Compliance with all applicable safety standards, including but not limited to fall restraint systems (ladders or other systems). Local safety authorities should be contacted as standards vary between jurisdictions.

3.3. Methods of Installation

Recommendations for installing Westeel Water Tanks should be closely followed to achieve the full strength of the tank, and to achieve adequate weather sealing. Warranty is void if the recommendations are not followed including but not limited to:

1. Wall sheets that are not specified for a given tier, are used.
2. Foundations are found to be inadequate or out-of-level.
3. Anchor bolts (cast-in-place, drill-in, chemical type or other) are found to be inadequate.

If using bin jacks, choose a hoist with a suitable capacity for the expected empty tank deadload. Make sure the rated capacity of the hoist is not exceeded.

3.4. Critical Assembly Requirements

To ensure a successful, safe and reliable outcome you must comply with the following assembly techniques and practices:

1. Comply with all local code and jurisdictional requirements applicable to your inspection hatch collar installation.
2. Design and build foundations with the necessary strength for the loads they must support, and for local soil conditions. Westeel foundation guidelines are based on specific stated conditions and may not be applicable to local conditions.
3. Your foundation must provide uniform and level support to the structure being supported. Surface imperfections causing gapping must be remedied. This may involve, but not be limited to a) grouting under the bottom ring of a non-stiffened bin or tank, and b) shimming under the uprights of a stiffened bin or tank, or under the legs of a hopper.
4. Make sure that the proper hardware is utilized for all bolted connections. If a shortage occurs, do not substitute. Take the necessary steps to obtain the proper hardware. Make sure nuts are tightened to the required torque values as specified in the appropriate assembly manual.

5. Comply with all assembly instructions provided in the appropriate assembly manual to make sure your whole inspection hatch collar is constructed safely. **Important: Do not deviate from the wall sheet and upright layouts provided.**
6. Before anchoring your structure to its foundation, make sure the structure is round. The maximum variation from perfect roundness is 3/4" on the radius. Locate anchor bolts toward the outside of the anchor bolt holes (away from the circle) to permit the incremental expansion that can occur with the initial filling.

3.5. Product Storage

Rust on Galvanized Parts

1. White rust forms when moisture is allowed to collect on galvanized surfaces that have yet to develop the durable zinc oxide layer. This zinc oxide layer naturally occurs as the surface interacts with carbon dioxide, and is characterized over time by the dull grey appearance that weathered galvanized surfaces get.
2. Parts that are not well ventilated or well drained can collect water between surfaces and develop white rust.
3. White rust is not a structural concern if its development is stopped in the early stages. A light film or powdery residue can occur after a period of heavy rainfall or a short time of improper storage. If white rust has started to develop, separate parts and wipe off any moisture. Next, using a clean cloth, apply a thin layer of petroleum jelly or food-grade oil to the entire part.
4. If moisture is left on parts, this white rust can become more aggressive and turn into red rust. Red rust can cause degradation in the material and become a structural concern. Any parts that have red rust should be replaced immediately.

Storage Guidelines

- Keep all bundles dry before assembly of the bin.
- Start assembly as soon as possible.
- Do not lay bundles on the bare ground; raise all bundles 6" – 8" off the ground on wood blocks or timbers. (See [Figure 2 on page 14](#) Detail A)
- Store curved wall sheets 'hump-up'. (See [Figure 2 on page 14](#) Detail A).
- All other bundles material should be placed so that they are well sloped to promote good drainage. (See [Figure 2 on page 14](#) Detail B).
- Roof sheets must be elevated at least 12" at the small end of the sheets (See [Figure 2 on page 14](#) Detail B).
- Temporary storage can be provided by erecting a simple framework supporting a waterproof tarp. (See [Figure 2 on page 14](#) Detail C)
- All hardware boxes should be stored inside. These are not waterproof, and will deteriorate in normal weather conditions, allowing moisture to contact the parts inside.

Figure 2. Product Storage

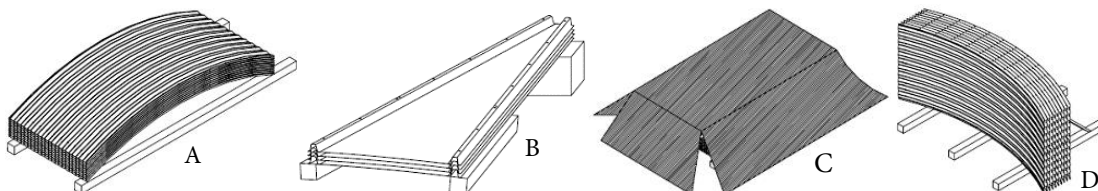

If Parts Become Wet

1. If goods become submerged or wet, the bundles should be opened as soon as possible, sheets or material separated and dried. Keep separated until assembly.

Brace goods properly so as to avoid damage or injury from material falling when in storage. (See [Figure 2 on page 14](#) Detail D).
2. Any boxed goods that become wet should be dried and stored in a new box that is free of moisture.
3. In addition to wiping down wall sheets, a food-grade oil can also be applied with a clean, lint-free cloth. This will assist in preventing any further moisture from contacting the galvanizing on the steel. Due to safety concerns with installation and use, Westeel does not recommend the use of oil on other parts such as roof sheets and safety ladders.

3.6. Important Notes

1. In order to maintain your wall sheets in good condition separate sheets and allow air circulation between them. Store sheets in a dry place. Do not store sheets with ends pointing upwards.
2. Contact local power officials for minimum power line clearance.
3. See the Tank Design and Capacity section of this manual for information about materials that can be stored in these vessels.
4. Tighten all bolts to the recommended torque setting (see Recommended Bolt Torques in the related installation layout document).

Note

Consistent with Westeel's policy of continued research and development of our products, we reserve the right to modify or change information contained in this publication without notice.

3.7. Planning and Timing

Before construction begins, even before the product is unpacked, some pre-planning is recommended. Consider the following:

Water tanks are generally constructed from the top down. The top tier of wall sheets and the roof are installed first. Then the tank is raised and other tiers are sequentially added. The best time to install components and accessories are when the tank is readily accessible and before the tank is raised such that the installation location is out of reach. It is advisable to construct a diagram of accessories and their relative location before construction so as not to forget these details during construction.

Some things to consider:

- The stencil wall sheet is usually facing the road or the yard. Consult the owner as to preferred location.
- Consideration should also be given to the orientation of the inspection hatch sheet, which is usually located on one side or other of the roof ladder.
- The sidewall ladder is usually lined up with the roof ladder. However lining up the ladder with the inspection hatch is another alternative. Similarly, platforms are normally installed beside the ladder and can likewise be positioned at the inspection hatch or roof ladder.
- If equipped with sidewall stairs, the location of the top platform must be given similar consideration. The spiral stairs can be installed to spiral down in a clockwise or counter-clockwise direction so this must also be considered.

- The locations of water level gauges, pipe penetrations and other accessories, relative to the other components and external features, must also be considered. Any penetrations through the wall sheets must **not** be made on a vertical bolt seam. Rather the penetrations should preferably be located towards the center of a wall sheet such that the hole and collars do not interfere with any structural bolt hole locations. It might also be necessary to support any equipment that is attached to the tank if it is excessively heavy and cannot support itself.

Some things to remember during the assembly of the tank include:

- Positioning the geotextile bag and liner in the center of the tank before it is completely closed-in is suggested.
- Roof and eve ladders, platforms, cages, stairs, etc should be installed when the first wall sheet tier and roof are completed and before the liner is attached. Any penetrations in the top tier should also be made at this time.
- Water gauges and other roof-mounted accessories should also be installed at this time.
- As the tank is being raised, remember to continue assembling the ladder and cages, or spiral stairs as you go.

4. Preparation

4.1. Check Shipment

Unload the parts at the assembly site and compare the packing slip to the shipment. Ensure that all items have arrived and that none are damaged.

Report damaged parts or shortages immediately to your dealer. Your dealer will order replacement parts immediately to ensure that assembly will not be held up by missing parts. All parts will be charged for and credit will be issued by party at fault. No credit will be issued if freight bills are signed as received in good condition.

4.2. List of Tools and Equipment

Use quality tools and equipment. Use them safely, and correctly, for their intended use. Tools for this application should include:

Tools

- Electric or pneumatic (air) impact tools
- Power drill and drill bits
- Sockets (multiple 9/16" and 1/2" sockets recommended)
- Large-pocket carpenter pouch
- 8" (20 cm) metal punches (for aligning bolt holes)
- Step and extension ladders, construction grade
- 6-point wrenches (Imperial, box end)
- Metal-cutting saw suitable for cutting roof rings and wind rings
- Scaffolding
- Centre-post bin stand
- Crane and/or bin jacks

Minimum Recommended Safety Equipment

- A properly-stocked first-aid kit
- Eye, foot, head, and hand protection (safety glasses, steel-toed boots, hard hat, work gloves)
- Cable, chain, or rope to tie-off bin or jacks in case of wind
- Body harness and lifeline (for use where falling hazard exists)
- Ground fault interrupt protected electrical hook-ups

4.3. Order Optional Equipment

Optional equipment such as unloading augers, aeration equipment, anchor bolts, foundation sealant, external ladders, safety cage and platforms, etc., should all be on site and checked before assembly starts. Plan your installation in advance. For details, see assembly instruction supplied with optional equipment.

5. Assembly



Before continuing, ensure you have completely read and understood this manual's Safety section, in addition to the safety information in the section(s) below.

5.1. Assembly Safety

WARNING

- Do not take chances with safety. The components can be large, heavy, and hard to handle. Always use the proper tools, rated lifting equipment, and lifting points for the job.
- Carry out assembly in a large open area with a level surface.
- Always have two or more people assembling the inspection hatch collar.
- Make sure you have sufficient lighting for the work area.
- Tighten all fasteners according to their specifications. Do not replace or substitute bolts, nuts, or other hardware that is of lesser quality than the hardware supplied by the manufacturer.
- Stay away from overhead power lines and other obstructions during assembly. Contact with power lines can cause electrocution.
- Do not work in high winds.
- The equipment shall be installed in accordance with applicable local codes and regulations.

5.2. Installation Instructions

This section provides instructions for installing inspection hatch collars on six-foot and nine-foot water tanks. The instructions are the same for both collars.

1. Position and bolt on the latch assembly (235891) to the roof panel.
 - a. Centre the latch assembly and place it as close to the start of the drip edge bend as possible.
 - b. Position all other components in relation to this first part.
2. Position the hatch collar (199278 for 6' tank / 199457 for 9' tank) so the bolt flange butts against the latch assembly as shown in

Figure 3. Inspection Hatch Details (9' - Optional)

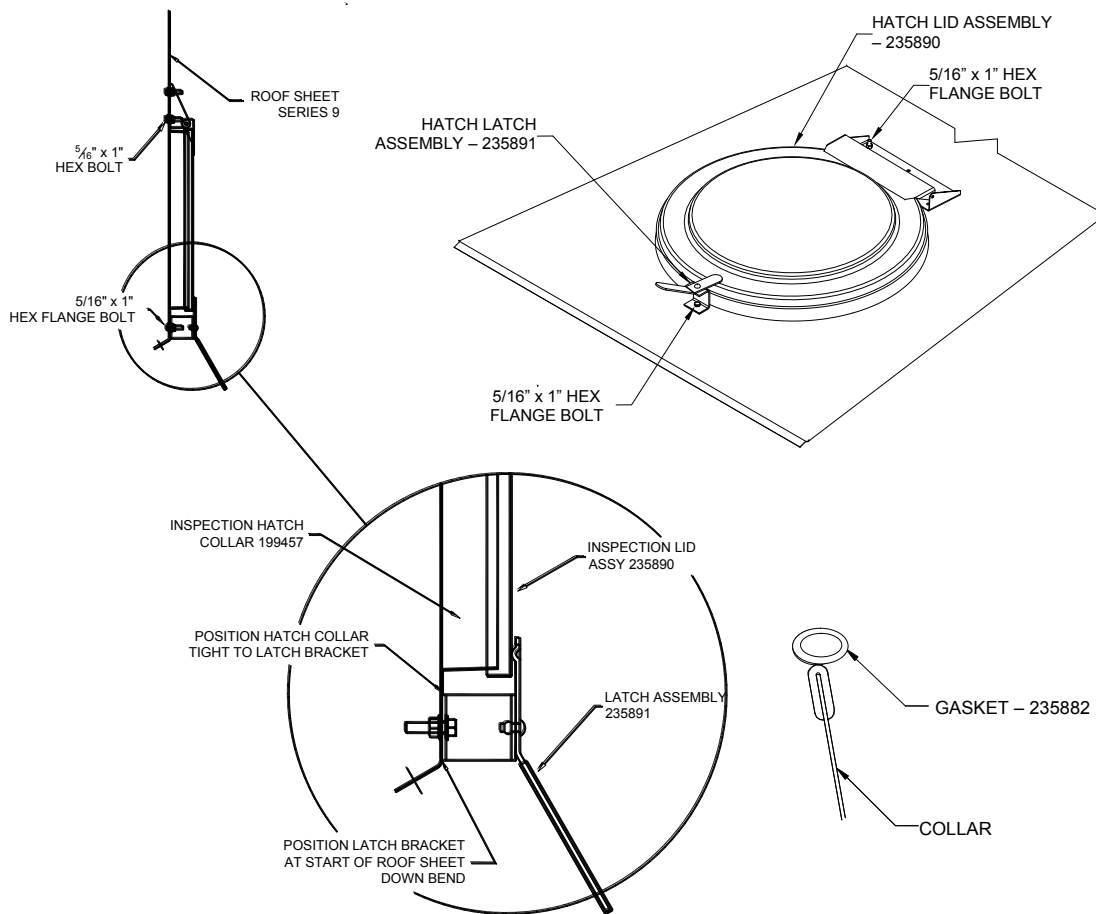

- a. Using the hatch collars as a pattern, mark the opening and bolt hole locations onto the roof sheet.
- b. Cut the opening and drill holes into the roof sheet.
 - If the collar is to be installed from the outside, cut the hole to the size of the traced hole.
 - If the collar is to be installed from the inside, cut the hole slightly larger than the flanged collar.

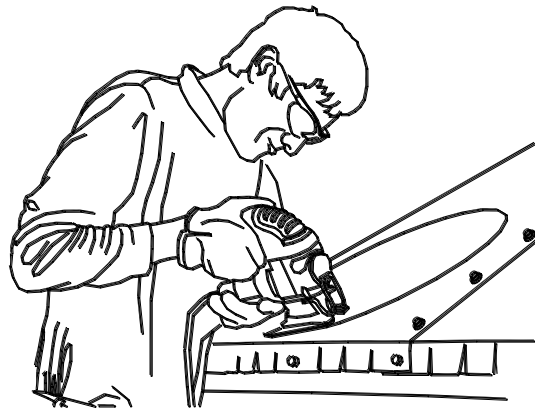
Figure 4. Cutting out the collar opening

- c. Bolt on the hatch collar with 5/16" x 1" bolts provided for the roof.
 - d. For best sealing results make sure the bolts are on the underside of the roof panel with the sealing washer pressed against the roof panel.
3. If there is any warping and the collar needs to be secured further, add TEK screws as necessary.
 4. Apply caulking (not supplied) to seal any gaps.
 5. Install the gasket, lid and latch as described in the appropriate installation manuals for 15' and larger roofs.
 - The hatch lid assembly part number for 6' tanks is 199279.
 - The hatch lid assembly part number for 9' tanks and 15' to 54' tanks is 235890.

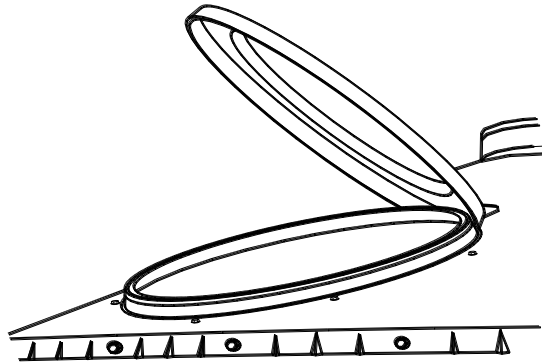
Figure 5. Installing the lid assembly

6. Appendix

6.1. Inspection Hatch Parts Boxes

Table 6. 16" Inspection Hatch Parts Box (199579)

Used on 6-ft water tank roofs

PART #	DESCRIPTION
185010	CARTON 37 X 37 X 9
199278	16" HATCH COLLAR
199279	16" INSPECTION HATCH ASSY
235882	GASKET 76" INSPECTION HATCH
235891	WC HATCH LATCH ASSY
235915	.313 X 1" BOLTS GR 8.2 (50)
235925	.313" NUTS (50)
235151	.25 X 1" TEC SCREWS (7)
199594	INSPECTION HATCH MANUAL

Table 7. 24" Inspection Hatch Parts Box (199580)

Used on 9-ft water tank roofs

PART #	DESCRIPTION
185010	CARTON 37 X 37 X 9
199457	HATCH COLLAR 24"
235890	WC HATCH LID ASSY
125882	GASKET 76" INSPECTION HATCH
235891	WC HATCH LATCH ASSY
235915	.313 X 1" BOLTS GR 8.2 (50)
235925	.313" NUTS (50)
235151	.25 X 1" TEK SCREWS (7)
199594	INSPECTION HATCH MANUAL

6.2. Recommended Bolt Assembly

When tightening bolts, tighten the nut on the bolt until a “snug-tightened condition” has been achieved. A “snug-tightened condition” is defined in *Specification for Structural Joints Using ASTM A325 or A490 Bolts* (Research Council on Structural Connections: June 2004), which states:







*“The snug-tightened condition is the tightness that is attained with a few impacts of an impact wrench or the full effort of an ironworker using an ordinary spud wrench to bring the connected plies into **firm contact**.”*

A properly tightened bolt will compress the sealing washer noticeably. All assembly crew members must be made aware of this requirement, and must know how to achieve a snug-tightened condition using common bin-building tools.

It is important that the bolts in the vertical wall sheet seams are tightened enough to squeeze the caulking and bring the wall sheet surfaces into firm contact with each other. This is especially important to monitor when installing bolts in temperatures approaching -10°C (14°F).

The following table shows the minimum impact gun torque capacity necessary to achieve a snug-tightened condition for bolts used in the assembly process.

Table 8. Recommended Impact Gun Torque Values Capacity to Achieve Snug-Tightened Bolts

Bolt Diameter	Bolt Grade	Grade Mark	Recommended Torque Capacity		
			in-lb	ft-lb	N-m
1/4"	Grade 8.2		75	6	8
5/16"	Grade 8.2		215	18	24
3/8"	Grade 8.2		370	31	42
7/16"	Grade 8.2		600	50	68
1/2"	Grade 8.2		960	80	108
5/8"	Grade 8.2		1800	150	203
3/4"	Grade 5		3230	269	365

For proper sealing, do not overtighten the wall seam connections. Sealing is not critical on upright splice connections; these connections should be tightened securely to prevent loosening.

Hold the bolt head securely when tightening the nut to prevent damage to the sealing washer.

Important

ALWAYS TIGHTEN THE NUT, NOT THE BOLT.

Avoid bin assembly at temperatures below -10°C (14°F) if possible. Erection in low temperatures does not ensure strong, well sealed connections. Do not substitute bolts in place of those supplied by Westeel.

7. Limited Warranty: Westeel Water Tank Containment Systems

Westeel – Ag Growth International (“Westeel”) warrants products for Water Tank Containment Systems that it has manufactured and/or that are branded with its name (the “goods”) subject to the following terms and limitations, (the “warranty”):

Duration of Warranty

The duration of the warranty is limited as follows:

- 10 years

The duration of the warranty will run from the date of purchase from a dealer or distributor authorized by Westeel (the "warranty period").

Exclusive Remedy — Replacement

Within the warranty period, Westeel will replace the goods and/or original manufactured components thereof which are found, to Westeel's satisfaction, to be defective. Westeel is not responsible for direct, indirect, special, consequential, or any other damages of any kind, including personal injury to any individual, howsoever caused, including caused by transportation of the goods for repair or replacement.

Procedure for Obtaining Service

In the event of a warranty claim, the purchaser must complete any and all information required by Westeel in order to properly assess or investigate the claim. Westeel will not be responsible for the removal of any of the goods found to be defective, or transportation charges to and from Westeel's authorized dealer or distributor, or for installation of any replacement goods and/or parts furnished under the warranty.

Limitations as to Scope of Warranty

The warranty does not extend to defects or damage caused, in whole or in part, by:

1. use of a kind and/or to a degree not reasonably expected to be made of the goods;
2. improper storage of the goods both prior to and after purchase;
3. damage caused by, or in the course of, installation or assembly;
4. any use of the goods which is not an intended use as specified in Westeel's published product literature, or otherwise specified by Westeel in writing;
5. any equipment attached to or used in conjunction with the goods that are not of Westeel's manufacture nor supplied by Westeel;
6. any field modifications or substitutions to original Water Tank Containment System components;
7. acidic environmental conditions affecting the structural integrity of the goods;
8. any other circumstance not in keeping with proper maintenance and/or use of the goods;

9. cosmetic changes such as white rust and scratches
10. Acts of God, accident, neglect or abuse of the goods by the purchaser and/or any other individual or entity; or
11. Any use or installation inconsistent with Westeel's Standard Disclaimers.

Limitations as to Manufacturer

The warranty does not cover products sold by Westeel that are not manufactured by Westeel. In those circumstances, the purchaser is referred to the manufacturer of those products.

Limitation of Implied Warranties and Other Remedies

To the extent allowed by law, neither Westeel nor its dealers, nor any company affiliated with Westeel makes any warranties, representations, or promises as to the quality, performance, or freedom from defect of any Product covered by this Warranty.

WESTEEL HEREBY DISCLAIMS, TO THE EXTENT APPLICABLE, ANY AND ALL IMPLIED WARRANTIES OF MERCHANTABILITY AND FITNESS FOR A PARTICULAR PURPOSE. A PURCHASER'S ONLY REMEDIES IN CONNECTION WITH THIS WARRANTY ARE THOSE SET FORTH IN THIS WARRANTY. IN NO EVENT WILL WESTEEL, ITS DEALERS, OR ANY COMPANY AFFILIATED WITH WESTEEL BE LIABLE FOR INCIDENTAL, CONSEQUENTIAL OR PUNITIVE DAMAGES.

Some jurisdictions do not allow waivers of certain warranties, so the above waivers may not apply to you. In that event, any implied warranties are limited in duration to ninety (90) days from delivery of the products. You may also have other rights which vary from jurisdiction to jurisdiction.

Exclusive Warranty

This warranty is the only warranty provided by Westeel and all other warranties and/or commitments, whether express or implied and no matter by whom made, statutory or otherwise, are subsumed and replaced by it and are of no legal effect. If any provision of the warranty is held by a court of competent jurisdiction to be void or unenforceable, in whole or in part, such provision shall be deemed severable and will not affect or impair the legal validity of any other provision of the warranty.



450 Desautels Street
P.O. Box 792
Winnipeg, Manitoba, R3C 2N5 Canada
Phone: 1-888-937-8335

Website: www.aggrowth.com
Email: customerservice.winnipeg@westeel.com
©Ag Growth International Inc. 2020
Printed in Canada

If you have any comments or questions on this manual, or find an error, email us at comments@aggrowth.com.
Please include the part number listed on the cover page in your message.
